

# Radsok<sup>®</sup>

## High Power Connectors

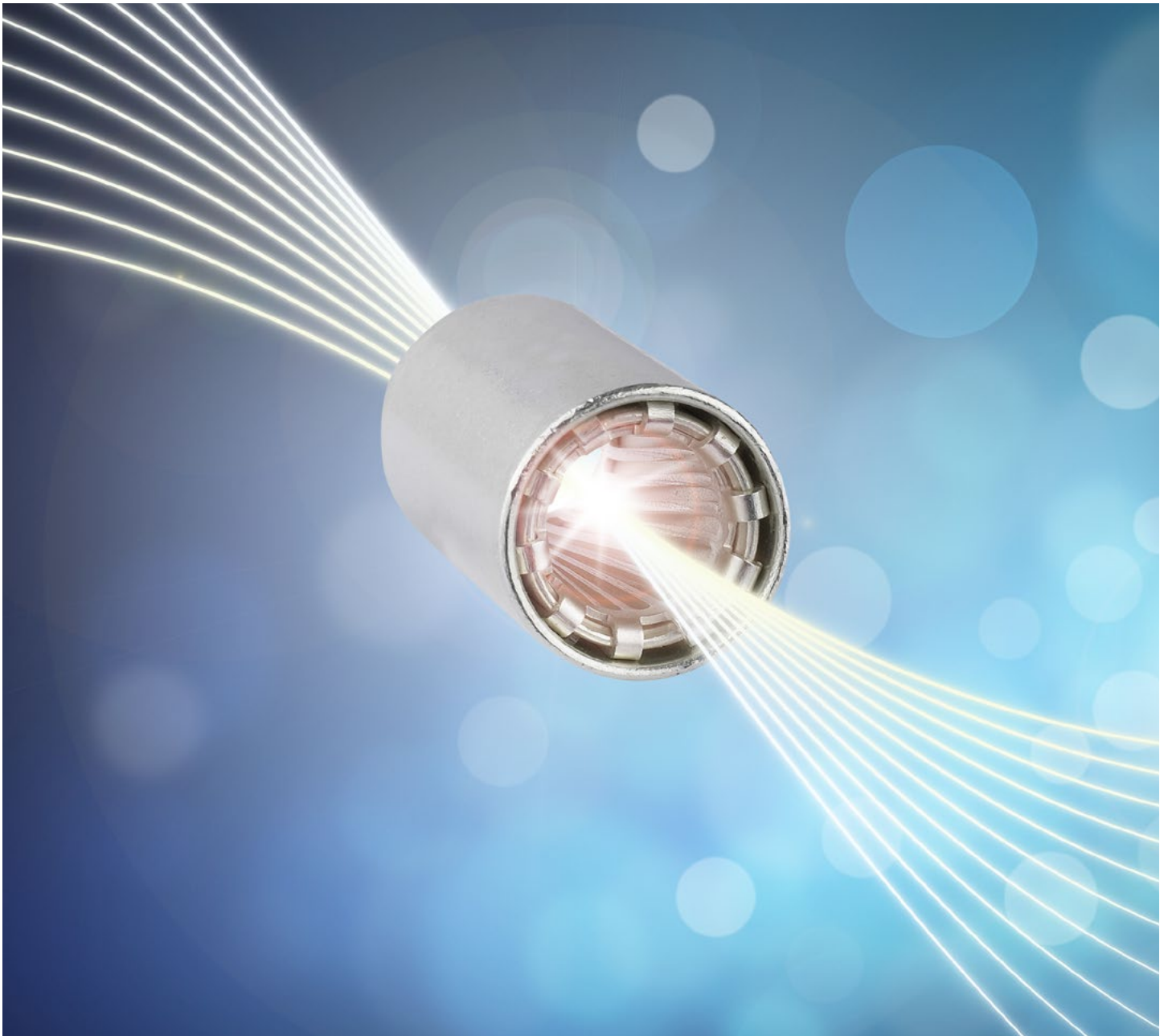

# Note from the CEO



## Ladies and Gentlemen,

For over 75 years Amphenol has enjoyed success as the interconnection technology provider of choice to industry-leading companies around the world. One of our key strategic areas of focus has been and is the Industrial market. Our organization works with leading manufacturers across a wide range of applications - including Energy Generation & Distribution, Transportation, Heavy Equipment, Factory Automation, Wireless Outdoor, ChipCard Readers - enabling smarter, faster and better technologies to connect products to customer solutions.

The Industrial market footprint of Amphenol covers over facilities in more than 12 different European countries and more than 30 countries worldwide. Our successful expansion into new regions as well as new industrial applications is a direct reflection of our agile, entrepreneurial management team and our unwavering commitment to execute Amphenol's strategies for the benefit of our customers, shareholders and employees.

Thank you for partnering with Amphenol. Our entire organization is at your service.

A handwritten signature in black ink, appearing to read 'R. Adam Norwitt'. The signature is fluid and cursive, with a long horizontal stroke at the end.

R. Adam Norwitt  
President and CEO, Amphenol Corporation

# Make use of the best

## Use our global resources

“Think global, act local!” Independently from where you are in Europe, we offer you our global expertise and great variety of products and technologies. And in comfort with your personal contact. Our numerous European offices are your access to our global resources.

### © OUR OFFICES IN EUROPE AND WORLDWIDE

|                |        |           |              |
|----------------|--------|-----------|--------------|
| FRANCE         | CHINA  | AUSTRALIA | SOUTH AFRICA |
| GERMANY        | KOREA  | MEXICO    | INDIA        |
| UNITED KINGDOM | TAIWAN | USA       | ITALY        |

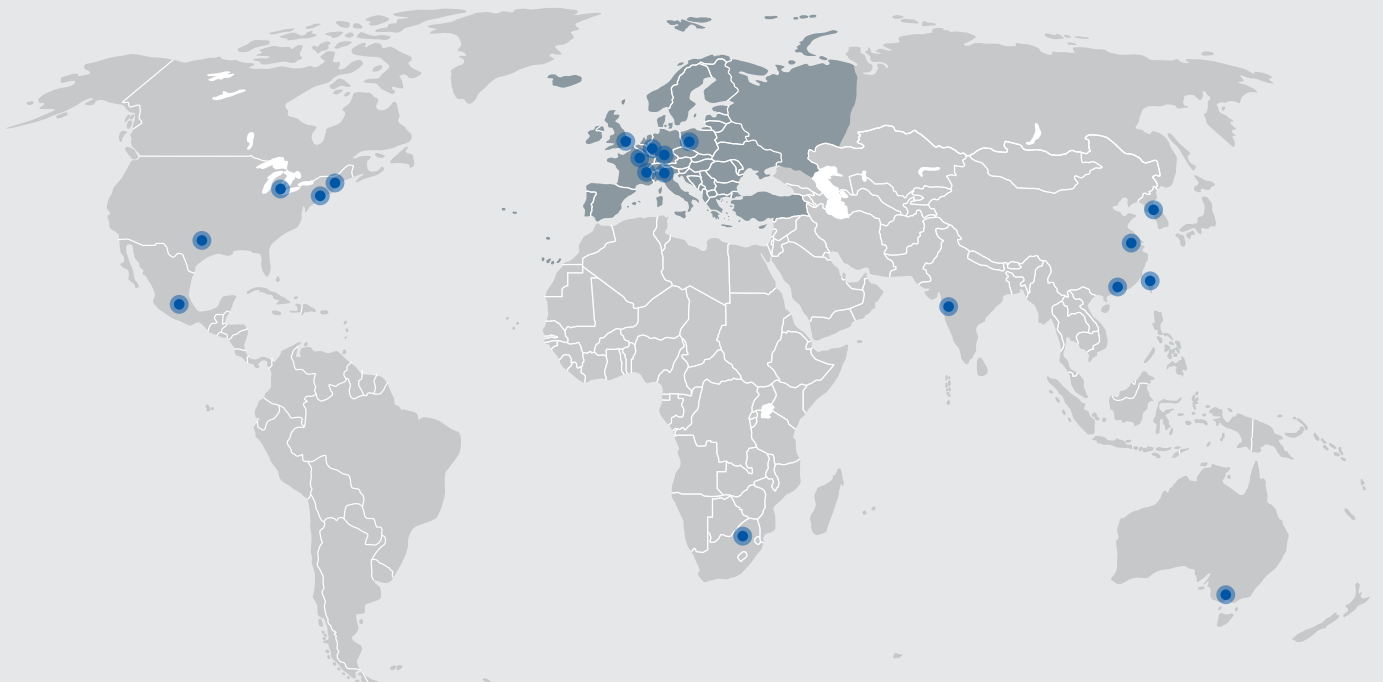



SECURITY, RELIABILITY AND COMFORTABLE SERVICE FROM ONE SOURCE.

# More time for important things: benefit from our service and diversity

Enjoy security, reliability and comfortable service from one source. INDUSTRIAL@AMPHENOL offers one of the most individual and most diversified service programmes in the market – exclusively for industrial customers. Access all possibilities of the Amphenol group through your personal expert adviser.



## WIDE PRODUCT RANGE

Take advantage of a choice of Amphenol products. Our broad product portfolio offers individual solutions from more than 85 member companies in the global Amphenol group.



## EXCLUSIVENESS AND FLEXIBILITY

One face to the customer: every inquiry is handled on an individual service level by your personal key account service partner. This ensures maximum transparency and best-in-class flexibility in the whole process.



## QUALITY

Interconnect systems need reliability, speed and flawless data transmission. We continuously test and guarantee the required standard in our products – and also in our personal services.



## INDIVIDUAL SOLUTIONS

Your project requires an individual solution that is not available off-the-shelf? As your think tank and discussion partner we provide engineering support and solution-oriented development for your tailor-made Amphenol product.



## SPEED AND AVAILABILITY

Smart and intelligent processes are the secret behind our service programme. Flexible planning and distribution, perfect logistics and highest availability are our key factors for best customer service.



## GLOBAL KEY ACCOUNT SERVICE

Our key account service is your individual entrance to global know-how, products and services. More than 85 Amphenol companies around the world offer an extensive range of technologies and products. We offer access to our worldwide resources through one individual contact person.

| Content   | Page      |
|---|-----------|
| 1 - Radsok basics   | 06        |
| 2 - Sub series  | 08        |
| <b>2.1 busbar   mate</b>  | <b>08</b> |
| High Power Connectors for busbar. 6.0 mm, 8.0 mm and 10.0 mm Radsok                                       |           |
| <b>2.2 board   mate</b>   | <b>10</b> |
| High Power Connectors for PCB-Applications. 3.6 mm, 6.0 mm and 8.0 mm Radsok                              |           |
| <b>2.3 ground   mate</b>  | <b>12</b> |
| High Power contacts for grounding or potential equalisation (PE). 3.6 mm, 6.0 mm and 8.0 mm Radsok        |           |
| <b>2.4 Radsok contacts and housings</b>   | <b>14</b> |
| High Power contacts and touch-proof housings. 3.6 mm, 6.0 mm and 8.0 mm Radsok                            |           |
| <b>2.5 Wallbushing Connector family</b>   | <b>16</b> |
| Feed-through-power Connector. 6.0 mm and 8.0 mm Radsok IP65/IP67 against the wall IP20 in mated condition |           |
| <b>2.6 Tools</b>  | <b>18</b> |
| Eletra hydraulic crimping unit and crimping dies.   |           |
| <b>2.7 Radsok industrial solutions</b>  | <b>20</b> |
| <b>2.8 press   mate</b>   | <b>22</b> |
| Radsok can be integrated in Standard cable lugs. 3.6 mm up to 16.0 mm Radsok                              |           |
| 3 - Deratings   | 24        |

More and more electrical and electronic components require higher amounts of energy. Conventional connection technology is not always able to meet such requirements. Pluggable connections are often no longer able to be applied. Amphenol offers a new generation of power contacts: Radsok. The hyperbolic construction offers many advantages such as contact coverage of up to 65 %, absorption of vibrations as well as durable stability of the contact elements. Current transfer of several hundred Ampere in addition to a high number of mating cycles is not a problem.

RADSOK means Radial Socket. The RADSOK terminal is a patented high performance hyperboloid socket style electrical contact system for applications >30 amps.. Hyperboloid connectors offer superior

performance compared to standard pin and socket connectors. In the RADSOK terminal, multiple contacting elements are hyperbolically arrayed around the inner diameter of the socket. In addition, each of the contact elements is skewed with respect to the axial direction of the terminal. The result is the multiple contact surfaces, comprising what is referred to as the “grid.” See also the picture on the next page.

When viewing the grid profile, a hyperbola shape is seen that is the basis of the unique RADSOK contact. The hyperbolic configuration results in a mechanical interference between an inserted pin and the contact elements. When a pin is inserted into the socket, the contacting elements of the grid mechanically wrap around the pin providing pressure (normal force) necessary for a superior electrical connection.

## Key Features

### LOW CONTACT RESISTANCE AND HIGH CURRENT CAPACITY

The grid provides a greater surface area of electrical contact per contacting element than standard contacts. RADSOK contacts do not relax as a result of repeated insertion, which occurs in standard terminals. The associated millivolt loss that is common in standard terminals due to repeated insertion relaxation does not occur with RADSOK. The result is superior electrical transfer that does not deteriorate from repeated insertion.

### VIBRATION RESISTANCE/OFF AXIS INSERTION TOLERANCE

The hyperbolic grid of the RADSOK terminal assures full contact with an inserted pin. Tests have confirmed that when subjected to vibration, this hyperbolic elastic grid maintains electrical continuity. This unique feature also provides for some axial misalignment without sacrifice of electrical contact.

### EXCELLENT DURABILITY

Certain applications require repeated insertion/extraction cycles. Due to its unique design and used materials the RADSOK contact is ideally fitted for applications with a high number of mating cycles while maintaining ability to carry high current capacity and withstand vibrations.

### SELF CLEANING LOW CONTACT RESISTANCE AND HIGH CURRENT

When talking about connectors it should be taken care to assure that the contact remain clean and free of contaminants to prevent voltage loss and heating. The design of the RADSOK contact provides a degree of self-cleaning. As the pin is inserted into the socket, the grid elements provide a wiping action that remove minor contaminants from the pin. The spaces between the grid elements provide space for contaminants.

## Radsok® Electrical Characteristics

All electrical measurements have been performed with RADSOK-terminals in standard configuration

| Attribute   |        | RADSOK        | 3,6                              | 6,0                               | 8,0                           |
|---|--------|---------------|----------------------------------|-----------------------------------|-------------------------------|
| Transition resistance                                   |        |               | < 0,2 mΩ                         | < 0,1 mΩ                          | < 0,1 mΩ                      |
| Typical Transition resistance<br>(for information only) |        |               | (0,15 mΩ)                        | (0,09 mΩ)                         | (0,06 mΩ)                     |
| <b>Continuous current carrying capacity</b>             |        |               |                                  |                                   |                               |
| Parameter   |        | cross section | 6, 10, <b>16</b> mm <sup>2</sup> | 10, 16, <b>25</b> mm <sup>2</sup> | 35, <b>50</b> mm <sup>2</sup> |
| Ambient temperature                                     | 20 °C  |               | 125 A                            | 190 A                             | 300 A                         |
|   | 85 °C  |               | 88 A                             | 135 A                             | 210 A                         |
|   | 125 °C |               | 60 A                             | 85 A                              | 130 A                         |
| <b>Max transmission duration for high power</b>         |        |               |                                  |                                   |                               |
| Ambient temperature                                     | power  |               |                                  |                                   |                               |
| 40 °C   | 200 A  |               | 40 s                             | 500 s                             | cont.                         |
|   | 500 A  |               | 2 s                              | 25 s                              | 100 s                         |
|   | 1000 A |               | 0,2 s                            | 3 s                               | 15 s                          |
| 100 °C  | 200 A  |               | 10 s                             | 120 s                             | 600 s                         |
|   | 500 A  |               | 0,9 s                            | 10 s                              | 40 s                          |
|   | 1000 A |               | 0,1 s                            | 1 s                               | 8 s                           |

## Radsok Mechanical Characteristics

Mating Force and Mating Cycles

| Attribute     |  | RADSOK | 3,6      | 6,0        | 8,0        |
|---------------|--|--------|----------|------------|------------|
| Mating Force  |  |        | 9 N (±3) | 21 N (±10) | 30 N (±12) |
| Mating Cycles |  |        | 1000     | 1000       | 1000       |

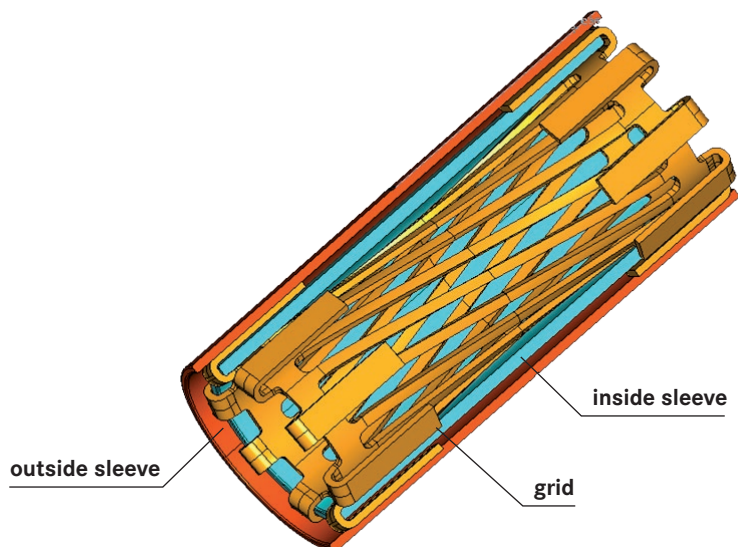

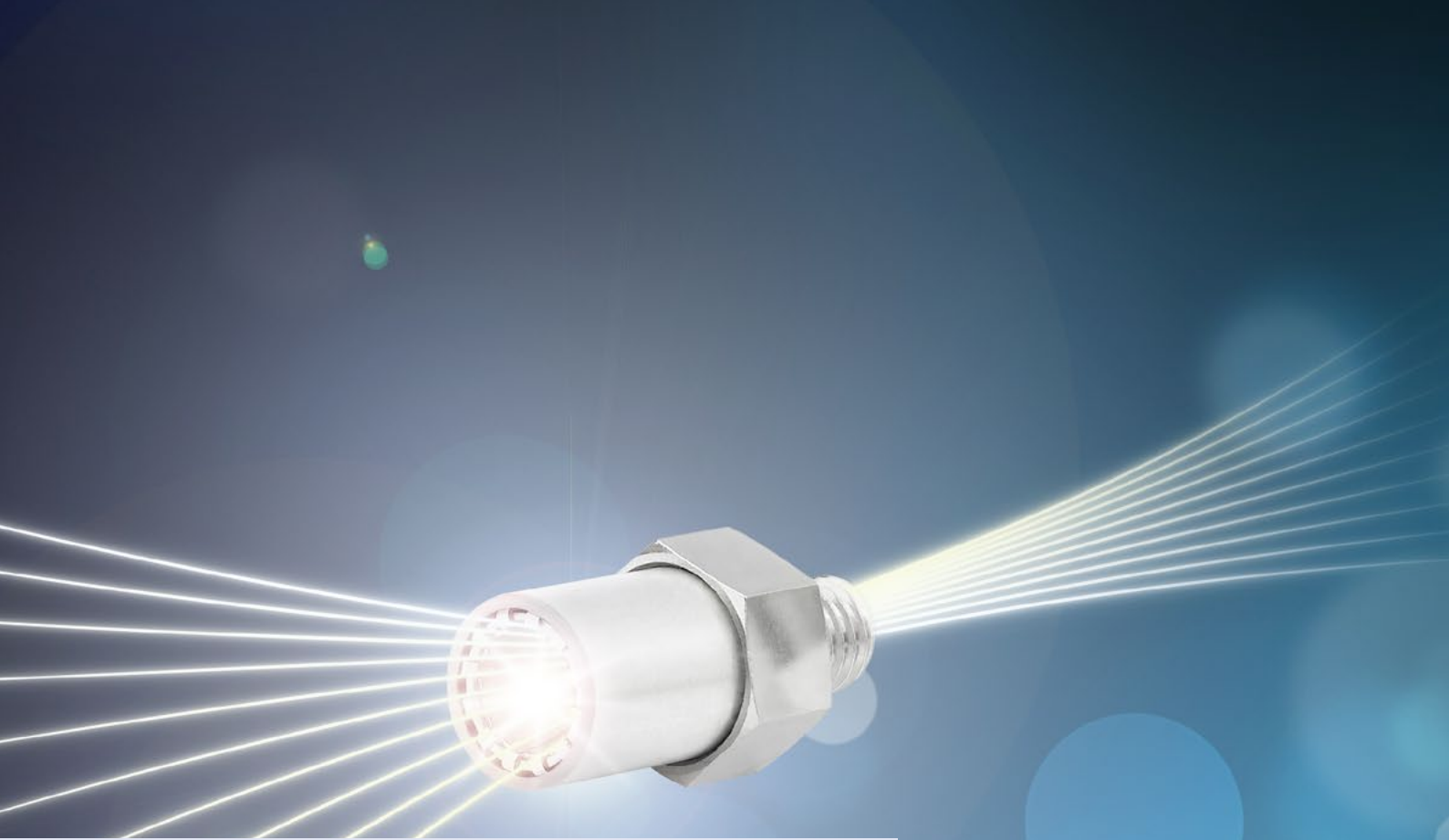



## busbar | mate

- **screw version**
- **available in 6 mm, 8 mm and 10 mm**
- **great solution for busbar**
- **maximum operating temperature (incl. selfheating) +150 °C**

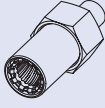

| Description                  | Part number       | Drawing  | Picture   |
|------------------------------|-------------------|--|---|
| Radsok 6 mm with thread M6   | N 02 060 6601 001 |  |  |
| Radsok 8 mm with thread M8   | N 02 080 6601 001 |  |  |
| Radsok 10 mm with thread M10 | N 02 100 6601 001 |  |  |

| Size                          | 6,0                                  | 8,0                                  | 10,0                                  |
|-------------------------------|--------------------------------------|--------------------------------------|---------------------------------------|
| <b>Mating partner</b>         |                                      |                                      |                                       |
| diameter                      | $\varnothing 5,95^{+0,05}_{-0}$      | $\varnothing 8,0^{+0}_{-0,05}$       | $\varnothing 10,0^{+0}_{-0,05}$       |
| surface roughness             | Ra=0,8                               |                                      |                                       |
| material                      | brass                                |                                      |                                       |
| surface contact area          | silver-plated min 6 $\mu\text{m}$    |                                      |                                       |
| minimum length                | 22 mm <sup>*1</sup>                  | 26 mm <sup>*1</sup>                  | 28 mm <sup>*1</sup>                   |
| <b>busbar</b>                 |                                      |                                      |                                       |
| through hole                  | $\varnothing 6,2 \pm 0,1 \text{ mm}$ | $\varnothing 8,2 \pm 0,1 \text{ mm}$ | $\varnothing 10,2 \pm 0,1 \text{ mm}$ |
| cross-section at contact area | 12 mm                                | 16 mm                                | 20 mm                                 |
| thickness                     | 2,8 mm min <sup>*2</sup>             | 3,2 mm min <sup>*2</sup>             | 3,6 mm min <sup>*2</sup>              |
| material                      | copper                               |                                      |                                       |

| Size   | 6,0   | 8,0   | 10,0  |
|--|-------|-------|-------|
| torque   | 8 Nm  | 12 Nm | 15 Nm |
| Thread   | M6    | M8    | M10   |
| Current carrying capacity at 85 °C ambient temperature <sup>*1</sup> | 134 A | 197 A | 230 A |
| Current carrying capacity at 85 °C ambient temperature <sup>*1</sup> | 112 A | 164 A | 190 A |

The screw-in Radsok contact has to be tightened in the busbar with a nut according to DIN EN24 032/ISO 4032 and a washer. At assembly the nut has to be hold an the screw-in Radsok contact hat bo be tightened with a torque according to table above.

<sup>\*1</sup> The current carrying capacity is depending on the ambient temperature, a potentially used cable (insulation, conductance/cross section, length, laying), used mating partner, busbar (contact area, material, cross-section) external heat sources, housing, supply air/cooling and quality of crimping.

<sup>\*2</sup> For mechanical stability the screw-in Radsok contact has to be tightened by a nut.

# board | mate

- **High Power for PCB**
- **available in 3.6 mm, 6 mm and 8 mm Radsok**
- **up to 75% quicker than screw connection**
- **compact design – requires less space**
- **Board-to-board and board-to-cable solutions**



Amphenol board|mate connectors combine high power contact technology from Amphenol and PCB blocks from Wuerth Elektronik. Instead of soldering they are pressed in into the circuit board so the board is no exposed to high temperature during soldering.

| description   | Part number         | drawing  | housing   |
|---|---------------------|--|---|
| <b>Solutions for 3.6 mm Radsok</b>  |                     |  |   |
| board mate pressfit pin - Radsok 3,6 mm   | N 01 036 6501 001   |    | -   |
| board mate pressfit socket - Radsok 3,6mm   | N 02 036 6501 001   |    | -   |
| crimp socket 3,6 mm<br>4-6 mm <sup>2</sup> cable diameter   | N 02 036 6126 001   |    | C360 G01 041 E1Z  |
| crimp socket 3,6 mm with <b>click fit</b><br>4 mm <sup>2</sup> -6 mm <sup>2</sup> cable diameter  | N 02 036 6136 002   |    | C360 G01 141 E1Z  |
| crimp socket 3,6 mm with Isola<br>6 mm-10 mm <sup>2</sup> cable diameter                          | N 02 036 6109 002   |    | C360 G01 241 E1Z  |
| crimp socket 3,6 mm with <b>click fit</b><br>6 mm <sup>2</sup> -10 mm <sup>2</sup> cable diameter | N 02 036 6137 002   |    | C360 G01 341 E1Z  |
| <b>Solutions for 6 mm Radsok</b>  |                     |  |   |
| board mate pressfit pin - Radsok 6,0 mm   | N 01 060 6501 001   |   | -   |
| crimp socket contact 6 mm<br>10 mm <sup>2</sup> -16 mm <sup>2</sup> cable diameter                | N 02 060 6121 002   |  | C360 G01 041 E2Z  |
| Crimpcontact for male contact<br>Ø6 mm <b>click fit</b><br>10-16 mm <sup>2</sup> cable diameter   | N 02 060 6164 002   |  | C360 G01 141 E2Z  |
| crimp socket contact 6 mm<br>25 mm <sup>2</sup> cable diameter                                    | N 02 060 6120 002   |  | C360 G01 241 E2Z  |
| crimp socket contact 6 mm with Isola-Crimp<br>25 mm <sup>2</sup> cable diameter                   | N 02 060 6165 002   |  | C360 G01 341 E2Z  |
| <b>Solutions for 8 mm Radsok</b>  |                     |  |   |
| board mate pressfit pin - Radsok 8,0 mm   | N 01 080 6501 001   |  | -   |
| board mate pressfit socket - Radsok 8,0 mm  | N 02 080 6501 001   |  | -   |
| crimp socket contact 8 mm<br>35 mm <sup>2</sup> -50 mm <sup>2</sup> cable diameter                | N 02 080 6121 002   |  | C360 G01 041 E3Z (35 mm)<br>C360 G01 241 E3Z (35 mm) <b>or</b><br>C380 10E004 241 2L (50 mm)<br>C380 G09 241 E3 (50 mm) |
| crimp socket <b>click fit</b> 8 mm<br>35-50 mm <sup>2</sup> cable diameter                        | N 02 080 6182 002 L |  | C360 G01 141 E3Z (35 mm)<br>C360 G01 341 E3Z (50 mm)  |

**Current Carrying Capacity**

The current carrying capacity of a connection using a boardmate connector needs to be seen in the context of the overall system.



**General Information**

Especially when talking about high current carrying capacity a lot of factors have to be considered, e.g. layout of the PCB or cooling system. The Press Fit zone has very low electrical contact resistance of 100 – 200 µOhm. The limiting factor therefor usually lies in the circuit board layout or in the connection of a feed line. The plugging elements have an electrical contact resistance of 0.2 mOhm at Ø 3.6 mm, 0.095 mOhm at Ø 6.0 mm, 0.075 mOhm Ø 10.3 mm and 0.028 mOhm at Ø 14.0 mm.

# ground | mate

- For grounding systems or Potential equalisation (PE)
- For power applications
- fast and easy mating
- secure and reliable contact system
- vibration-proof solution

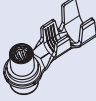
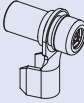

| description   | Part number         | drawing  | housing  |
|---|---------------------|--|--|
| <b>Solutions for 3.6 mm Radsok</b>  |                     |  |  |
| crimp socket 3,6 mm with <b>click fit</b><br>4 mm <sup>2</sup> -6 mm <sup>2</sup> cable diameter  | N 02 036 6136 002   |  | C360 G01 141 E1Z                                     |
| crimp socket 3,6 mm with <b>click fit</b><br>6 mm <sup>2</sup> -10 mm <sup>2</sup> cable diameter | N 02 036 6137 002   |  | C360 G01 341 E1Z                                     |
| <b>Solutions for 6 mm Radsok</b>  |                     |  |  |
| crimp socket contact 6 mm<br>10-16 mm <sup>2</sup> cable diameter                                 | N 02 060 6164 002   |  | C360 G01 141 E2Z                                     |
| Crimpcontact for male contact<br>Ø6 mm <b>click fit</b><br>25 mm <sup>2</sup> cable diameter      | N 02 060 6165 002   |  | C360 G01 341 E2Z                                     |
| <b>Solutions for 8 mm Radsok</b>  |                     |  |  |
| crimp socket <b>click fit</b> 8 mm<br>35-50 mm <sup>2</sup> cable diameter                        | N 02 080 6182 002 L |  | C360 G01 141 E3Z (35 mm)<br>C360 G01 341 E3Z (50 mm) |

- no tooling
- quick and easy assembly by plugging
- standard bolt or thread (for grounding)
- hidden assembly possible
- easy maintenance
- axial assembly (e.g. in line) possible

SAVE 50-60% ASSEMBLY TIME  
COMPARED TO BOLTED RING  
TERMINAL SOLUTIONS

YOUR BENEFITS

- optional touch proof housing available
- secure and reliable contact system
- fast and easy mating saves time and assembly cost
- optical and haptic feedback
- no torque control necessary
- Locking on pins with nut or on threads
- compatible to M6 and M8 threads

**Amphenol**  
Amphenol-Tuchel Electronics GmbH

**Resumed Test Report**  
No. 426000-1431-0016

**ground|mate**® 

**Pluggable earth/grounding contact**

Tested type approved acc. to VDE test and certification institute:  
**Declaration of usability of Radsok® contacts as a grounding contact or a connection for grounding termination**



Test and test report based on IEC 61984 and DIN VDE 0660-500  
(For test details please see report reference No 426000-1431-0016/79471 dated 03.05.2007)

Connectors – Safety requirements and test, rated voltages 50 V – 1000 V;  
Rated current up to 125 A for each pole

Test results acc. to DIN VDE 0660-500

**Description of test item:**  
Radsok® high current connector for pins without thread  
Radsok® high current connector for pins with thread M6 or M8

**Device under test:**  
Radsok® 6 mm with crimped cable 10 mm<sup>2</sup>  
Radsok® 8 mm with crimped cable 35 mm<sup>2</sup>

**Contact resistance:**  
Pin with thread M6: 0.22 mΩ  
Pin 6 mm without thread: 0.16 mΩ  
Pin with thread M8: 0.14 mΩ  
Pin 8 mm without thread: 0.11 mΩ

**Temperature range (IEC 60512):**  
-40 ... +125°C

**Short term current - and surge current stress (I<sub>pk</sub>, I<sub>cw</sub>, DIN VDE0660-500)**  
Test values

|                            |         |        |       |
|----------------------------|---------|--------|-------|
| Short term current         | 2.25 kA | 4.5 kA | 20 kA |
| Short circuit current (AC) | 1.5 kA  | 3 kA   | 10 kA |
| Duration of short circuit  | 1 s     | 1 s    | 1 s   |

Depending on the respective application the duration of short circuit stress needs to be adjusted.  
For shorter turn-off times of protective devices (typical in the range of milliseconds, according to VDE 0641 Part 11 / 8.92 EN 60 898 < 0,1 s) higher short circuit currents are applicable.

**Examples subject to the test report (with declaration of rated peak I<sub>pk</sub> and duration of short circuit):**

**Radsok 6 mm**  
20 kA – 20 ms short circuit strength  
8 kA – 228 ms short circuit strength  
4.78 kA – 633 ms short circuit strength

**Radsok 8 mm**  
20 kA – 179 ms short circuit strength  
8.14 kA - 745 ms short circuit strength

**Amphenol**  
Amphenol-Tuchel Electronics GmbH  
August-Haeusser-Str. 10 • 74090 Heilbronn • Germany • Phone +49/7131/929-0 • Fax +49/7131/929-486 • www.amphenol.info



## contacts & housings

- **Touch proof housings**
- **available in 3.6 mm, 6 mm, 8 mm**
- **vibration proof**

There are three categories of housings for Radsok contacts. Each housing fits to a specific contact so please check for additional information when choosing the contact.

## HOUSINGS WITH INTEGRATED LOCKING

- for 3.6 mm Radsok, 6 mm radsok and 8 mm Radsok

| Part number              | cable diameter        |
|--------------------------|-----------------------|
| <b>for 3.6 mm Radsok</b> |                       |
| C360 G01 041 E1Z         | 4-6 mm <sup>2</sup>   |
| C360 G01 241 E1Z         | 6-10 mm <sup>2</sup>  |
| <b>for 6 mm Radsok</b>   |                       |
| C360 G01 041 E2Z         | 10-16 mm <sup>2</sup> |
| C360 G01 241 E2Z         | 25 mm <sup>2</sup>    |
| <b>for 8 mm Radsok</b>   |                       |
| C360 G01 041 E3Z         | 35 mm <sup>2</sup>    |
| C360 G01 241 E3Z         | 50 mm <sup>2</sup>    |

"Z" stands for 400 pcs per packing unit. Please consider when ordering.

## HOUSINGS FOR CLICK|FIT

- for 3.6 mm Radsok, 6 mm radsok and 8 mm Radsok

| Part number              | cable diameter        |
|--------------------------|-----------------------|
| <b>for 3.6 mm Radsok</b> |                       |
| C360 G01 141 E1Z         | 4-6 mm <sup>2</sup>   |
| C360 G01 341 E1Z         | 6-10 mm <sup>2</sup>  |
| <b>for 6 mm Radsok</b>   |                       |
| C360 G01 141 E2Z         | 10-16 mm <sup>2</sup> |
| C360 G01 341 E2Z         | 25 mm <sup>2</sup>    |
| <b>for 8 mm Radsok</b>   |                       |
| C360 G01 141 E3Z         | 35 mm <sup>2</sup>    |
| C360 G01 341 E3Z         | 50 mm <sup>2</sup>    |

"Z" stands for 400 pcs per packing unit. Please consider when ordering.

## HOUSINGS WITH ACTIVE PINLOCK CONNECTOR

- for 8 mm Radsok
- Mating- / unmating force: < 45N
- Pullout force: ≥ 500N (once only)
- Mating cycles: min. 1000
- Voltage level: ≤ 60V DC/AC (higher level on request)
- Temperature range: -40 °C to 125 °C, short time 150 °C
- Accepted wire range: 35 and 50 mm<sup>2</sup>
- Material: housing, cover and locking slider: PBT GF30

| description                        | Part number                            |
|------------------------------------|--|
| Housing black without coding       | C380 10E004 241 2L                     |
| Cover for cable 35 mm <sup>2</sup> | C380 10E004 241 E3L / C380 G09 241 E3L |
| Cover for cable 50 mm <sup>2</sup> | C380 10E004 341 E3L / C380 G09 341 E3L |
| Crimp contact Radsok               | N02 080 6121 002L                      |

"L" stands for 50 pcs per packing unit. Please consider when ordering.



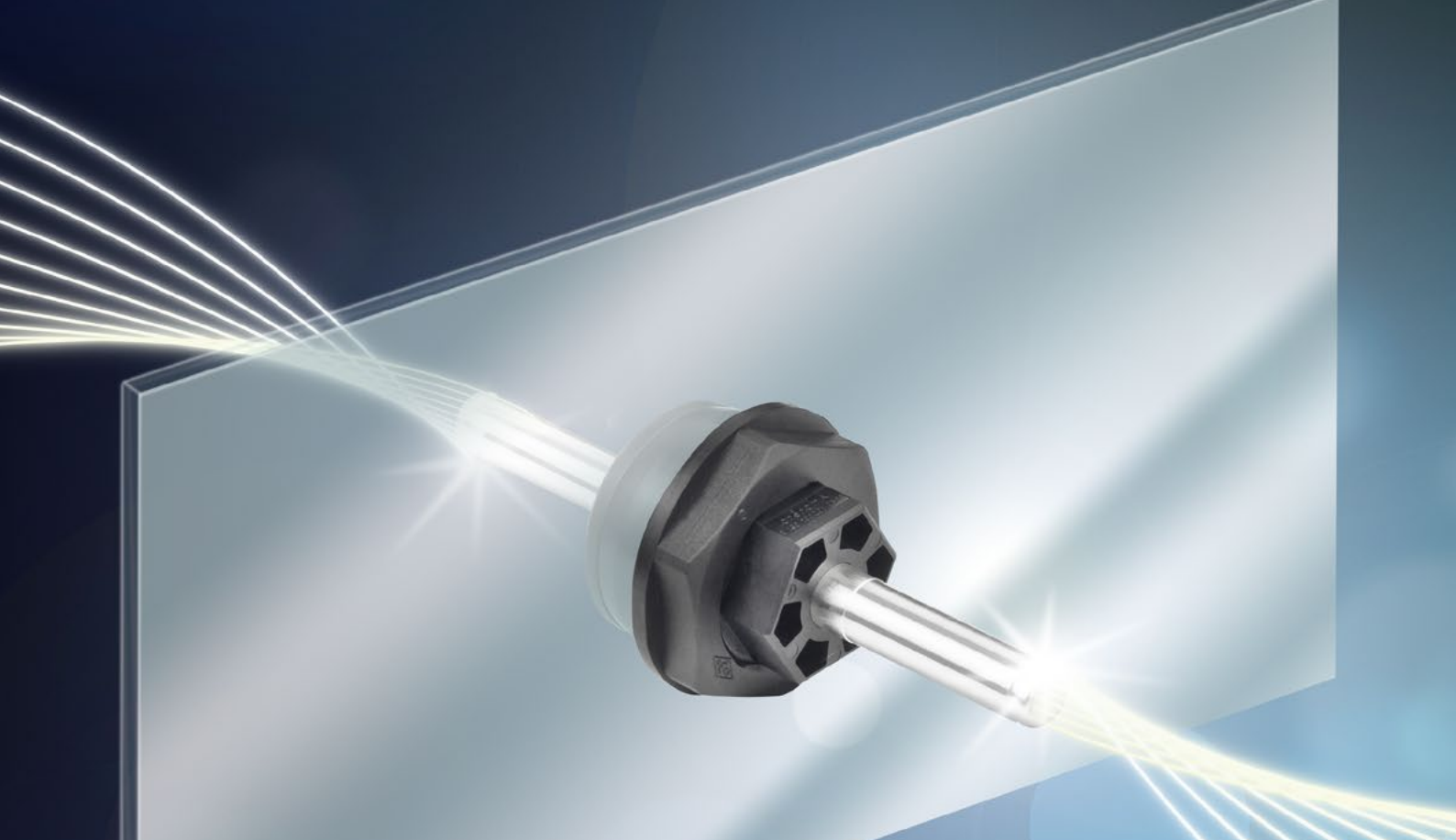





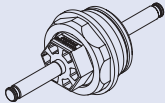
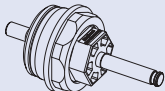
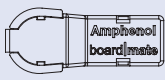

## wallbushing connector

- **Power distribution connector**
- **available for 6 mm and 8 mm Radsok**
- **easy and fast assembling from one side!**
- **fast mating and unmating without any tool**

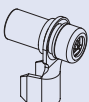

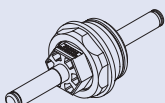
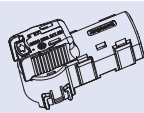
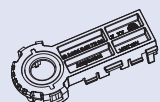
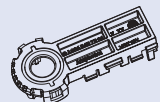
# Radsok® wallbushing connector

| description   | Part number        | drawing   |
|---|--------------------|---|
| <b>6 mm Radsok - wallbushing connector</b>                            |                    |   |
| 6 mm Wallbushing Connector  | C360 10D001 001 2  |    |
| 6 mm Wallbushing Connector universal port                             | C360 10D001 002 2  |    |
| <b>6 mm Radsok - sockets and housings</b>                             |                    |   |
| Housing black for 10 mm <sup>2</sup> -16 mm <sup>2</sup> cable        | C360 G01 141 E2    |    |
| Housing black for 25 mm <sup>2</sup> cable                            | C360 G01 341 E2    |    |
| Crimp contact Radsok for 10 mm <sup>2</sup> -16 mm <sup>2</sup> cable | N02 060 6164 002   |    |
| Crimp contact Radsok for 25 mm <sup>2</sup> cable                     | N02 060 6165 002   |   |
| <b>8 mm Radsok - wallbushing connector</b>                            |                    |   |
| Wall bushing Connector  | C360 10D001 001 3  |  |
| <b>8 mm Radsok - sockets and housings</b>                             |                    |   |
| Housing black without coding  | C380 10E004 241 2L |  |
| Cover for 35 mm <sup>2</sup> cable                                    | C380 G09 241 E3L   |  |
| Cover for 50 mm <sup>2</sup> cable                                    | C380 G09 341 E3L   |  |
| Crimp contact Radsok for 35 mm <sup>2</sup> -50 mm <sup>2</sup> cable | N02 080 6121 002L  |  |



# tools

- Tools needed to crimp Radsok contacts

FOR CRIMPING RADSOK CONTACTS YOU NEED:

- **Electro Hydraulic Crimping Unit**  
Amphenol p/n TE 0500 or  
KLAUKE p/n EK12042L  
NEKO p/n: APHW400C

- **Crimping dies**  
Regarding on contact  
(see below)



| Crimping dies            |   | Contacts    |  |
|--------------------------|---|-------------|--|
| Part number              | comment                                       | Part number | comment  |
| <b>for 3.6 mm Radsok</b> |   |             |  |
| TE 0500-101              | Radsok 3,6 mm for cable 4 - 6 mm <sup>2</sup> | ←           | N 02 036 6126 001<br>crimp socket 3,6 mm<br>4-6 mm <sup>2</sup> cable diameter   |
|                          |   | ←           | N 02 036 6136 002<br>crimp socket 3,6 mm with <b>click   fit</b><br>4 mm <sup>2</sup> -6 mm <sup>2</sup> cable diameter        |
| TE 0500-082              | Radsok 3,6 mm with isola-crimp for AWG 8      | ←           | N 02 036 6109 002<br>crimp socket 3,6 mm with Isola<br>6 mm <sup>2</sup> -10 mm <sup>2</sup> cable diameter                    |
|                          |   | ←           | N 02 036 6137 002<br>crimp socket 3,6 mm with Isola<br>6 mm <sup>2</sup> -10 mm <sup>2</sup> cable diameter <b>click   fit</b> |
| <b>for 6 mm Radsok</b>   |   |             |  |
| TE 0500-081              | Radsok 6 mm for cable 10 mm <sup>2</sup>      | ←           | N 02 060 6121 002<br>crimp socket contact 6 mm<br>10 mm <sup>2</sup> -16 mm <sup>2</sup> cable diameter                        |
| TE 0500-061              | Radsok 6 mm for cable 16 mm <sup>2</sup>      | ←           |  |
| TE 0500-041              | Radsok 6 mm for cable 25 mm <sup>2</sup>      | ↔           | N 02 060 6120 002<br>crimp socket contact 6 mm<br>25 mm <sup>2</sup> cable diameter  |
| TE 0500-081              | Radsok 6 mm for cable 10 mm <sup>2</sup>      | ←           | N02 060 6164 002<br>Crimpcontact for male contact Ø6 mm <b>click   fit</b><br>10-16 mm <sup>2</sup> cable diameter             |
| TE 0500-061              | Radsok 6 mm for cable 16 mm <sup>2</sup>      | ←           |  |
| TE 0500-041              | Radsok 6 mm for cable 25 mm <sup>2</sup>      | ↔           | N02 060 6165 002<br>Crimpcontact for male contact Ø6 mm <b>click   fit</b><br>25 mm <sup>2</sup> cable diameter                |
| <b>for 8 mm Radsok</b>   |   |             |  |
| TE 0500-011              | Radsok 8 mm for cable 35 - 50 mm <sup>2</sup> | ←           | N 02 080 6121 002<br>crimp socket contact 8 mm<br>35 mm <sup>2</sup> -50 mm <sup>2</sup> cable diameter                        |
|                          |   | ←           | N 02 080 6103 002<br>crimp socket contact 8 mm<br>35 mm <sup>2</sup> -50 mm <sup>2</sup> cable diameter                        |
| TE 0500-011              | Radsok 8 mm for cable 35 - 50 mm <sup>2</sup> | ↔           | N02 080 6182 002 L<br>crimp socket <b>click   fit</b> 8 mm<br>35-50 mm <sup>2</sup> cable diameter                             |



# Industrial Solutions

- **Industrial@Amphenol product series using Radsok technology**

As mentioned before Radsok is not only a product but a contact technology. Within INDUSTRIAL@AMPHENOL this technology is used within following product series:

### HEAVY | MATE

Heavy duty rectangular connectors that are using monoblock or modular inserts. By using the modular system 6 mm and 10 mm Radsok can be used in combination with IP65, IP67 or IP68 housings. For further information please see our homepage or contact your sales contact person.

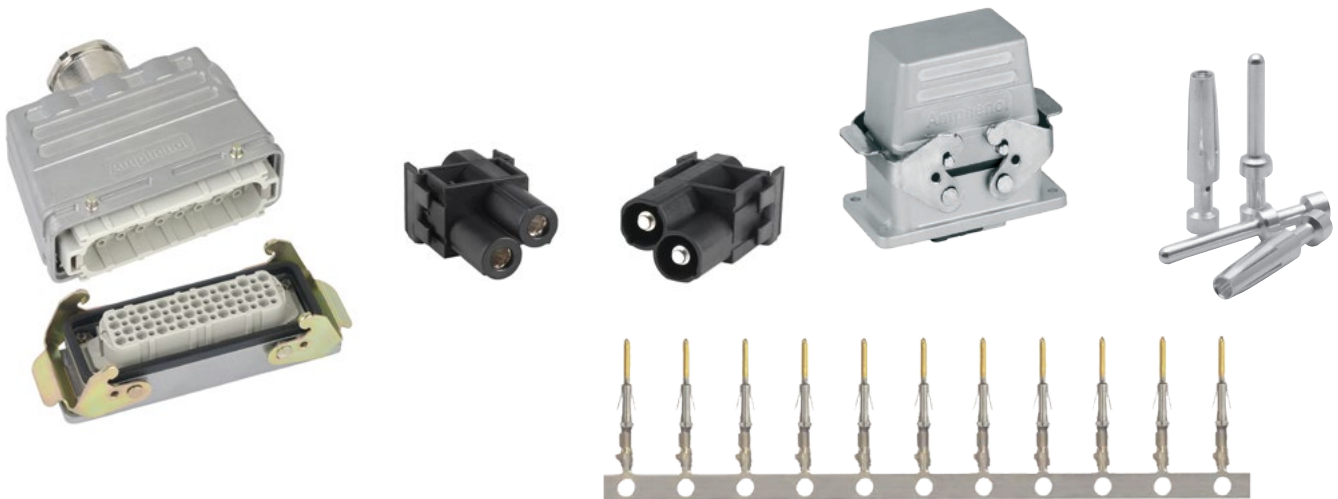

### ECOMATE RM

Circular metal connectors that are also using Radsok contacts. The subseries ecomate RM high amperage connectors enables using almost all major Radsok sizes: 3,6 mm, 8 mm and 10 mm Radsok. Housings can go up to IP67. For further information please see our homepage or contact your sales contact person.





## press | mate

- brand new patented technology
- Radsok can be integrated in Standard cable lugs
- available from 3 up to 16 mm Radsok  
(enables solutions with more than 400A at 45°C)

**AVAILABLE**  
**Q3 2015**

By using our brand new patented technology we can integrate Radsok contacts in standard cable lugs. As a result of this also standard tools for cable lugs can be used – by using 16 mm Radsok we can go over 400 A.

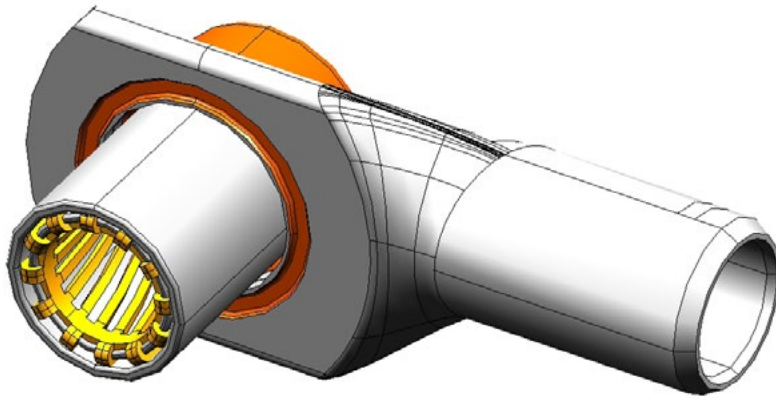

- reliable and secure contact system
- vibration proof
- can be used for power and grounding applications
- no special tooling required
- 360° rotatable

## CUSTOMIZE

Customizing possible at a certain volume.

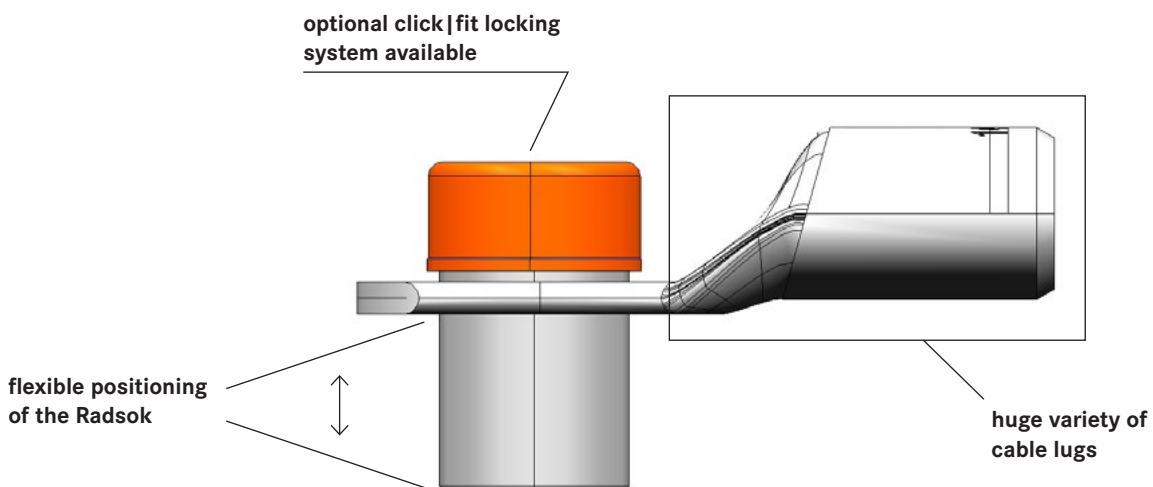

**Contact your sales representative for additional information!**

Derating 3,6 mm Radsok

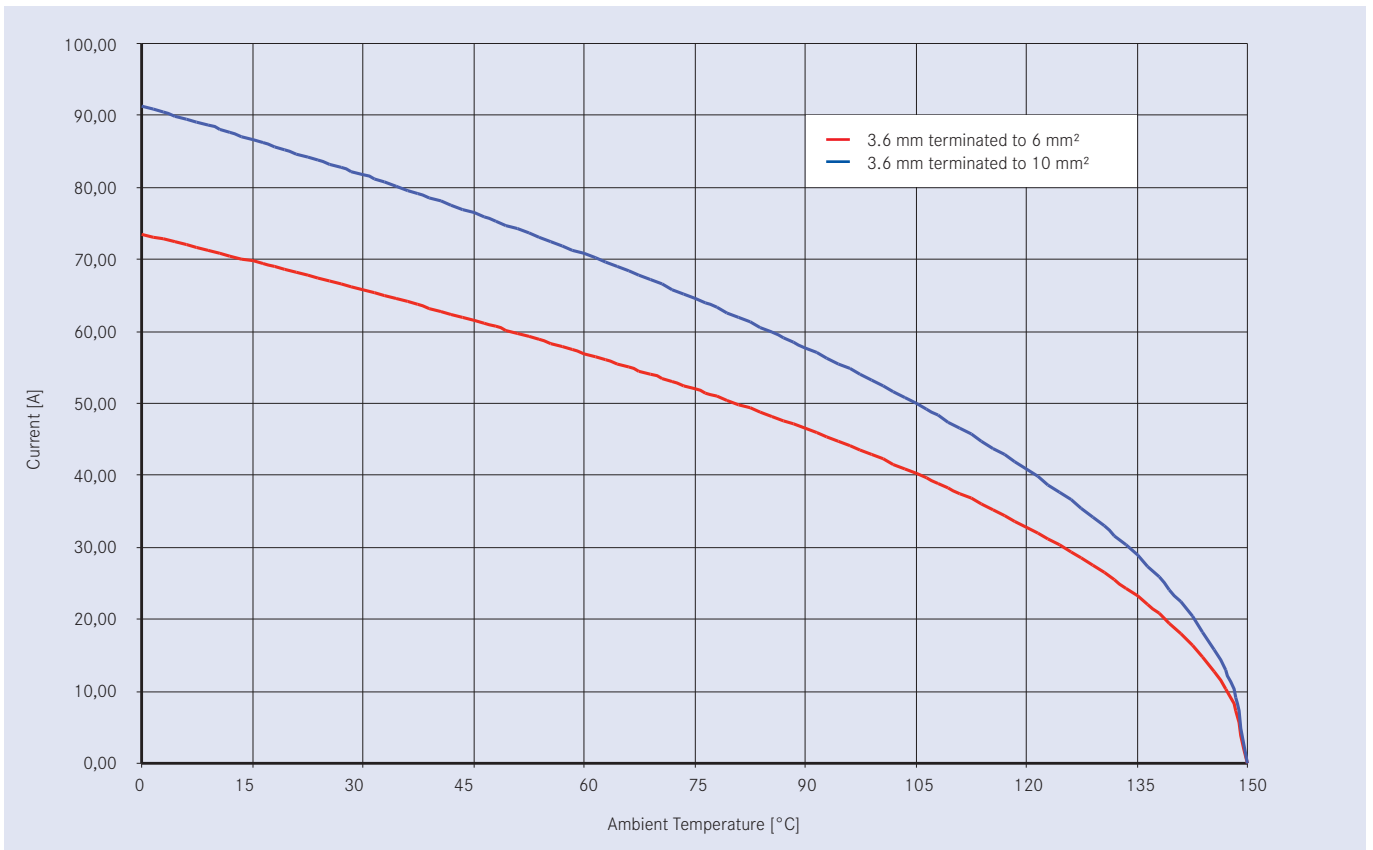

Derating 6 mm Radsok

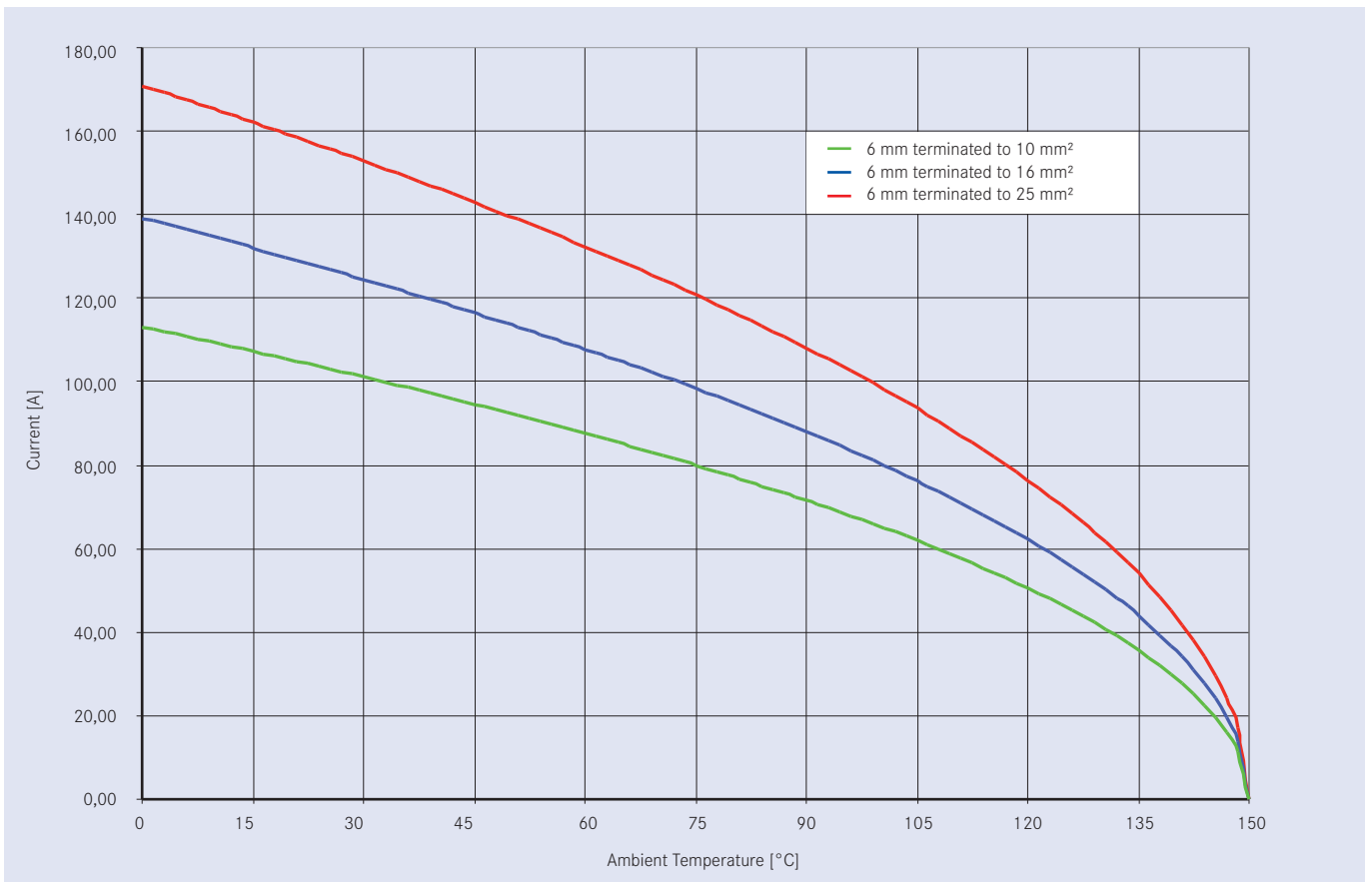

Remark: The given electrical values correspond to a single contact. With the addition of a housing, an increased number of poles or other modifications the values must be adjusted downwards accordingly



Derating 8 mm Radsok

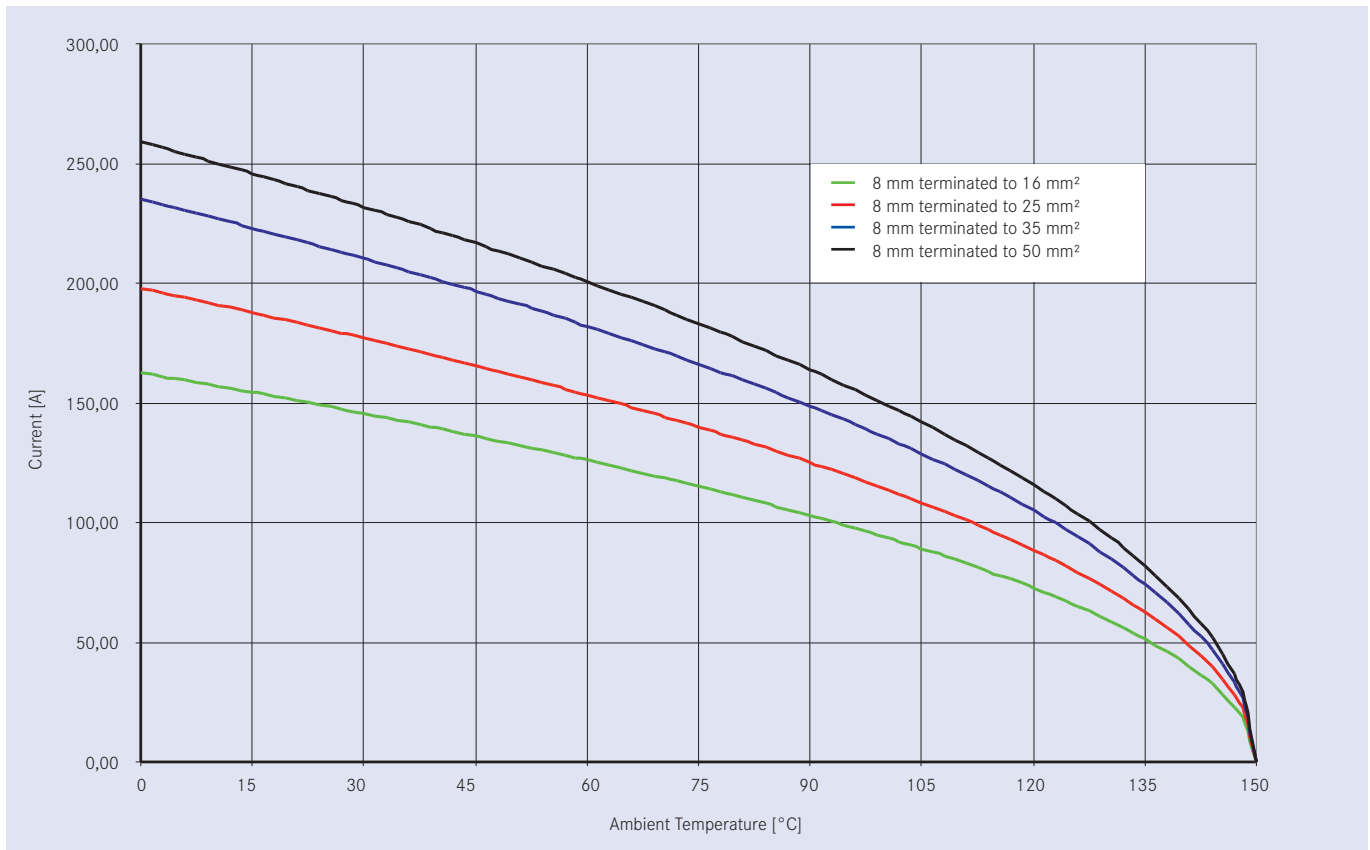

Derating 10 mm Radsok

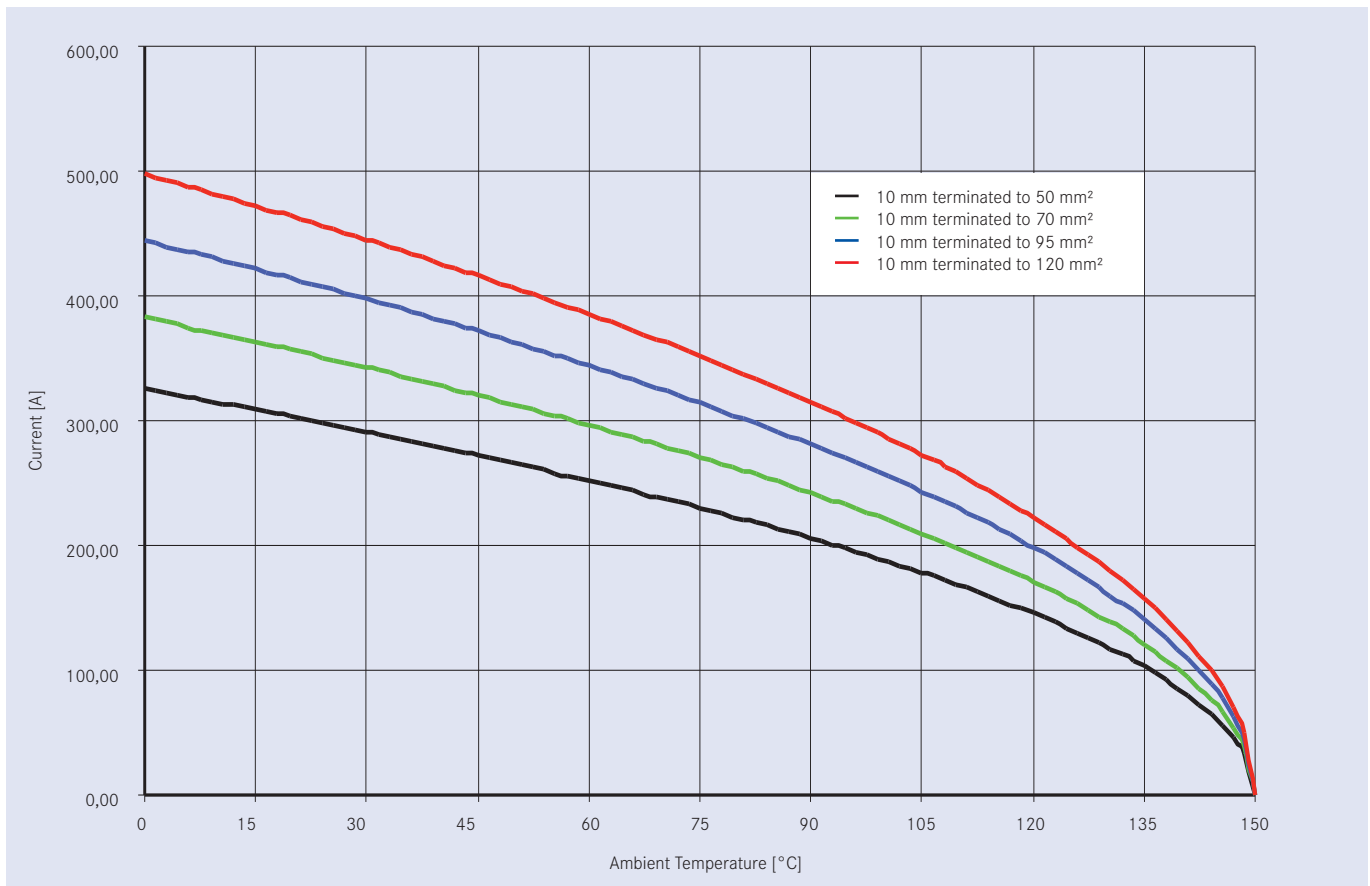





## International

### Argentina

Amphenol Argentina  
Av. Callao 930  
2nd Floor Office B "Plaza"  
C1023 AAP Buenos Aires  
Phone +54 11 4815 68 86  
www.amphenol.com.ar

### Australia

Amphenol Australia Pty. Ltd.  
2 Fiveways Blvd  
Keysborough  
Victoria 31 73  
Phone +61 3 8796 88 88  
www.amphenol.com.au

### Brazil

Amphenol do Brasil Ltda.  
Rua Diogo Moreira 132, 20th Floor  
CEP 05423-101 Sao Paulo SP  
Phone +55 11 3815 10 03  
www.amphenol.com.br

### China

Amphenol-Tuchel Electronics  
China Branch  
20 Tianshan Road  
Changzhou 213022  
Phone +86 519 85 11 03 01  
www.amphenol.info

### France

Amphenol Socapex S.A.S.  
948, Promenade de l'Arve, BP 29  
Thyez Cedex, 74311  
Phone +33 4 5089 28 00  
www.amphenol-socapex.com

### Germany

Amphenol-Tuchel Electronics GmbH  
August-Haeusser-Str. 10  
74080 Heilbronn  
Phone +49 7131 929 0  
www.amphenol.de

### India

Amphenol Interconnect India Pvt Ltd  
105, Bhosari Industrial Area  
Pune - 411 026  
Phone +91 20 2712 04 81  
www.amphenol-in.com

### Italy

Amphenol-Tuchel Italy  
Via Barbaiana n. 5  
20020 Lainate (MI)  
Phone +39 02 9325 41  
www.amphenol.info

### Korea

Amphenol DaeShin Elect and  
Precision Co.,Ltd  
558 Songnae-Dong, Sosa-Gu  
Bucheon-City, Kyunggi-Do  
Korea 422-130  
Phone +82 32 6103 800  
www.amphenol.co.kr

### Mexico

Amphenol Mexico  
Prolongacion Reforma 61 - 6 B2  
Col. Paseo de las Lomas  
C.P. 01330 Mexico D.F.  
Phone +52 55 5258 99 84  
www.amphenolmexico.com

### Singapore

Asia Pacific Sales Operations  
72 Bendemeer Rd, No.03-32/33  
Hiap Huat House, Luzerne, 339941  
Singapore  
Phone +65 6294 2128  
www.amphenol.com

### South Africa

Amphenol International Ltd  
Chislehurst  
30 Impala Road  
2196 Chislehurst  
Sandton, 2146  
Phone +27 11 7839 517  
www.amphenol.co.za

### Spain

Amphenol Espana  
Edificio Burgosal, Oficina 55  
C/Comunidad de Madrid, 35 bis  
Las Rozas (Madrid), 28230  
Phone +34 91 6407 302  
www.amphenol.com

### Taiwan

Amphenol East Asia Limited-Taiwan  
5F, No. 361, Fusing 1st Rd  
Gueishan Township,  
Taoyuan County 333  
Phone +886 3 2647 200  
www.amphenol.com

Amphenol LTW Technology Co., Ltd.  
9F, No. 657-12, Zhongzheng Road  
Xinzhuang Dist., New Taipei City  
242 Taiwan  
Phone +886 2 2908 5626  
sales@ltw-tech.com  
www.amphenolltw.com

### Turkey

Amphenol Turkey  
Sun Plaza Kat: 15  
Maslak Mah. Bilim Sok.No:15  
34398 Sisli - Istanbul  
Phone: +90 2123 679 220  
www.amphenol.com.tr

### United Kingdom

Amphenol Limited  
Thanet Way, Whitstable  
Kent, CT53JF  
Phone +44 1227 773 200  
www.amphenol.co.uk

### USA

Amphenol-Tuchel Electronics /  
Amphenol Sine Systems  
44724 Morley Drive  
48036 Clinton Township, MI  
Phone +1 586 913 8630  
www.amphenol.info

Amphenol Corporation  
Corporate Headquarters  
358 Hall Avenue  
Wallingford, CT 06492  
Phone +1 877 2674 366  
Phone +1 203 2658 900  
www.amphenol.com

More Amphenol companies can be  
found here: [www.amphenol.com](http://www.amphenol.com)



### Important Notice

All technical data have been measured in a laboratory environment and can be different during practical usage of the product. Any product information is for descriptive usage only and not legally binding; particularly the information does not constitute or provide any legal guaranties ("Beschaffensgarantie" or "Haltbarkeitsgarantie").

We reserve the right to change the design due to improvement in quality, development or production requirements. This catalogue must not be used in any form or manner without our prior approval in writing (Copyright Law, Fair Trading Law, Civil Code).

Your engineering sales representative: